

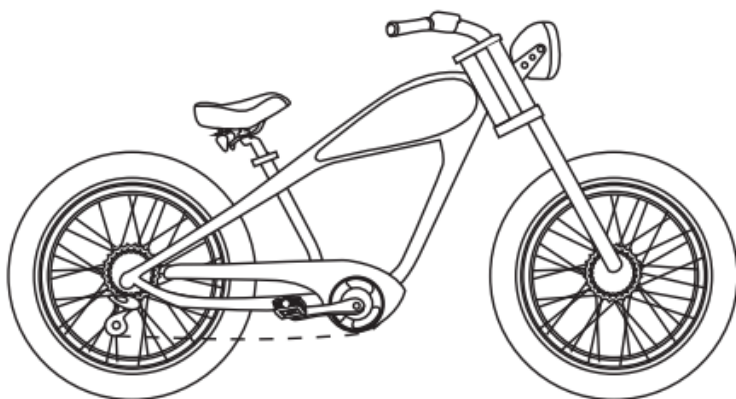

**MJM WHEELS LTD.**



**RT-20**

***USER'S MANUAL***

Thanks for purchasing an MJM WHEELS™ RT-20 fat tire retro electric bike. MJM WHEELS™ is based in CANADA, producing high-quality and unique style electric bike with high-profile components.

Open the carton box and take out your RT-20 carefully. The package has following items:

RT-20	CHARGER	PEDALS	FRONT WHEEL AXLE	F/R REFLECTOR
-------	---------	--------	------------------------	------------------

Remove all zip ties and packing material, being careful when it comes to the edge of the frame, tire and rim.

**Follow steps to assembly your RT-20 ebike**

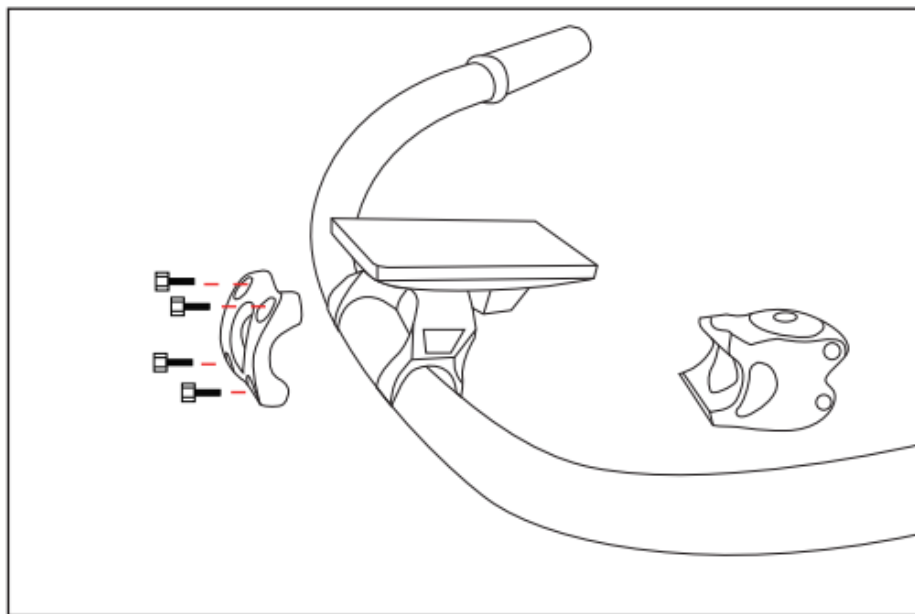

## Install Handle Bar

Loosen the bolts to put handle bar in between.

Use the reserved 4 bolts to install handle bar as picture shown.

Adjust handle bar angle and then tighten the 4 bolts to 20N.M.

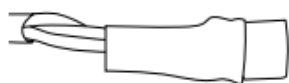
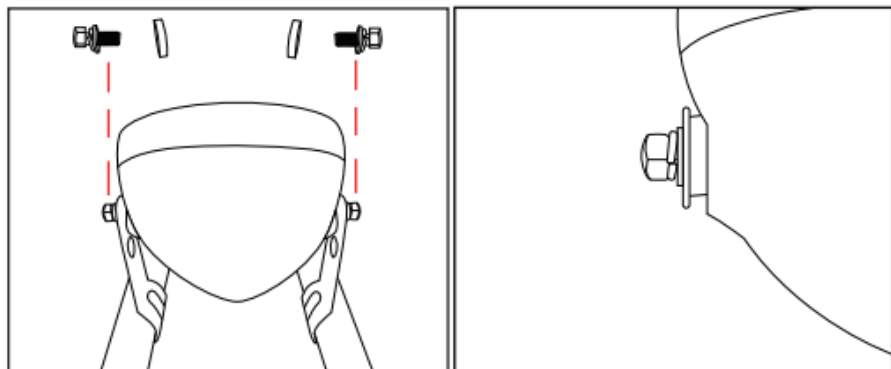
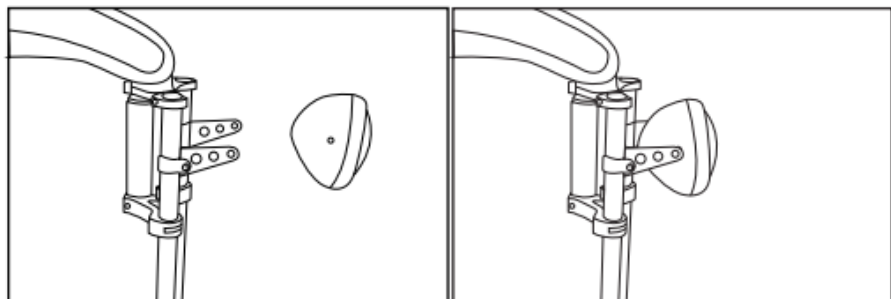

headlight



frame

## Install Head Light

Use reserved bolts and bushing to install head light. Adjust height and angle, then fasten all the bolts.

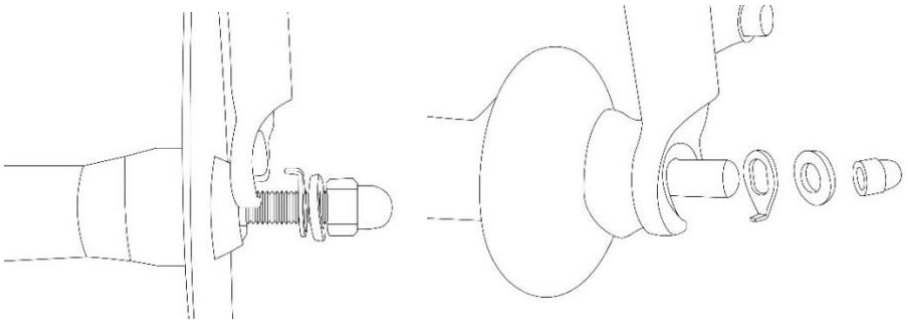
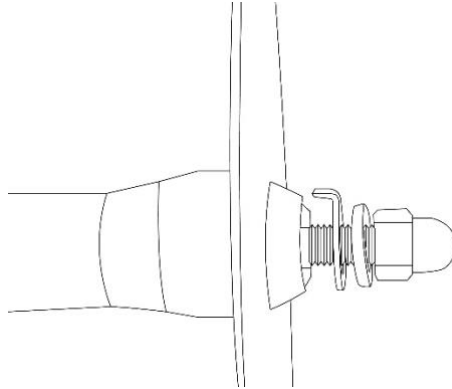
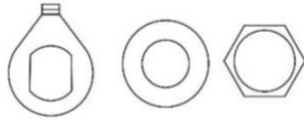

## Install Front Wheel

Make sure the brake disc is placed in the center of caliper gap and front wheel can rotate freely without any noise.

When the brake disc is not in the gap, DO NOT pull brake lever.

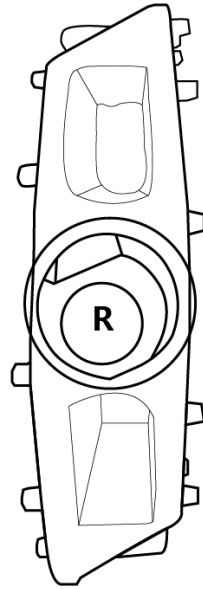
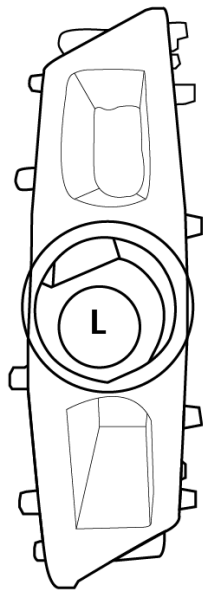

## Install Pedals

Use the pedal marked with an “L” on the left side and the right pedal marked with an “R” on the right side (side with drivetrain gears). The right-side pedal has a right-hand thread (removes counterclockwise, installs clockwise); the left side pedal has a left-hand thread (removes clockwise, installs counterclockwise). Be careful to not cross thread the pedals.

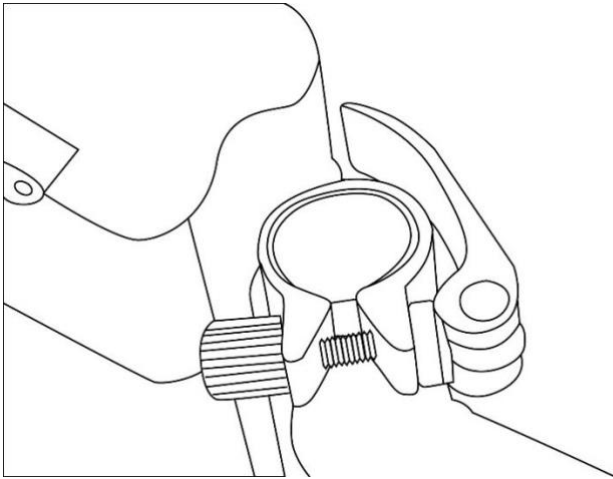
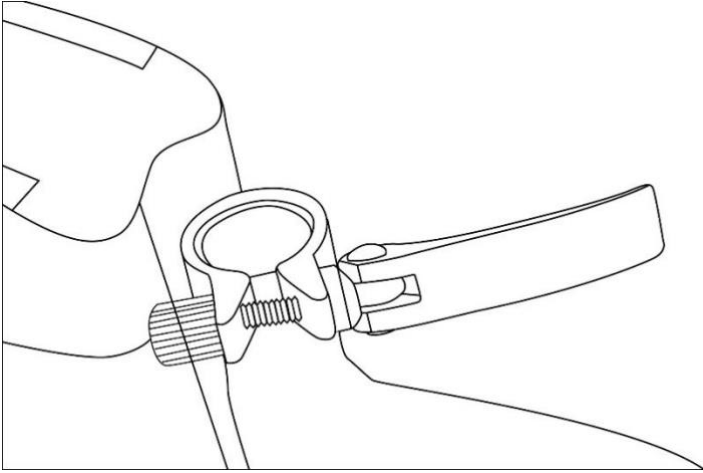

Insert, Remove or Adjust Saddle Height

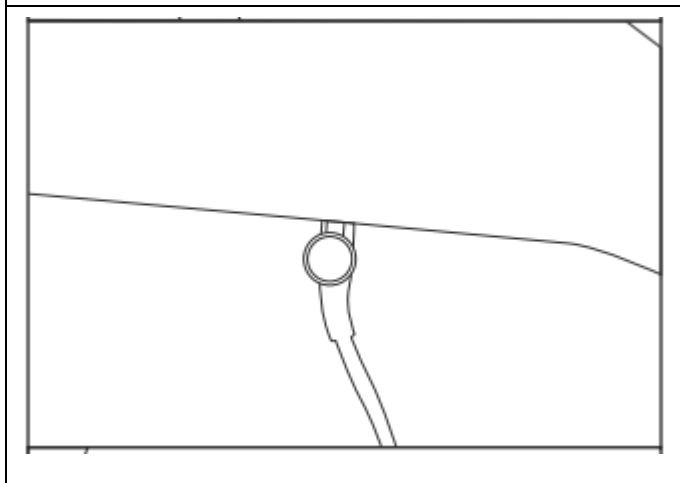
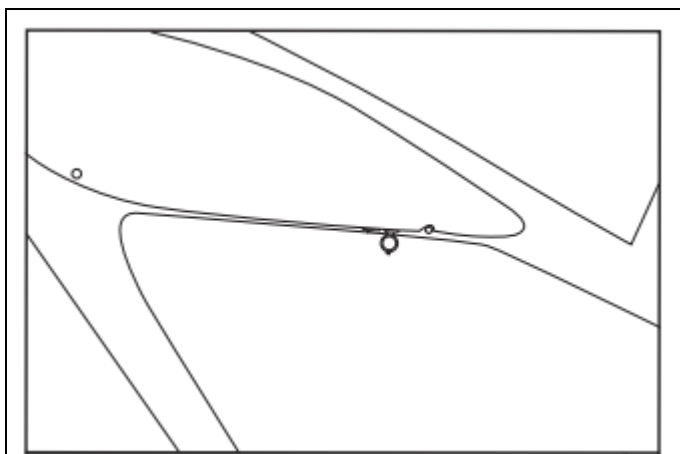



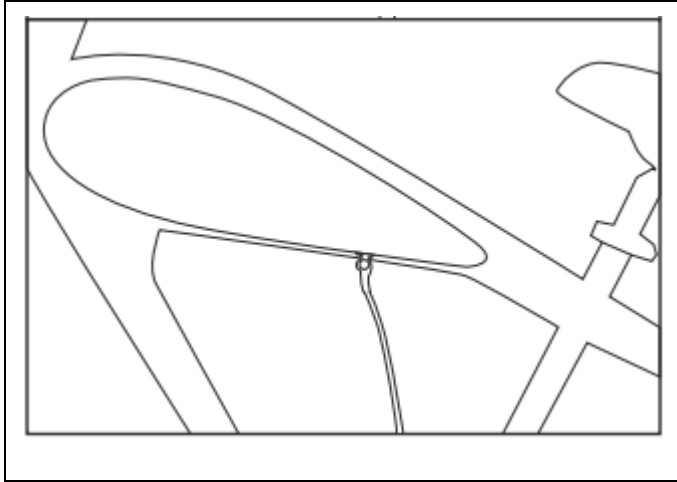

## Charge Battery before Your First Ride

\*On the charger adapter, the red light stands for charging, while green light stands for charging finished.

Make sure to charge your battery to full capacity before first ride.

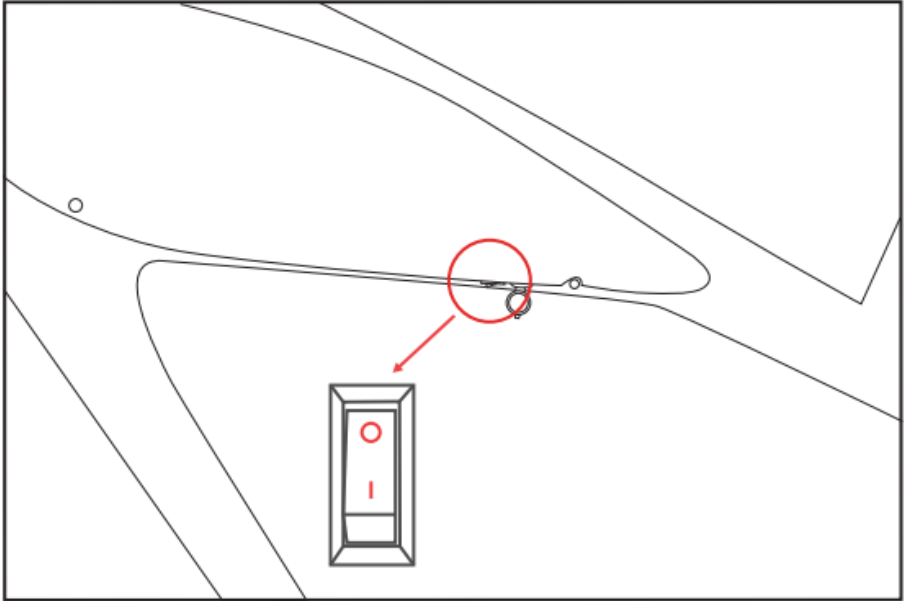

## Power ON/OFF your battery

Beside the charging port, you will find a separate switch to power ON/OFF your battery.

Make sure you switch on before your ride, and switch off after ride.

It helps protect the battery from draining itself.

## Some Battery Tips

- Lithium battery capacity is reduced every time they have been used.
- MJM WHEELS™ genuine battery provides 600~800 charging cycles.
- Stay away from extreme environment. The suggested temperature operating limits for the battery is -10C to 45C. Do not store need excessive heat.
- Do not allow the battery to be submerged in water or to be shorted out.
- The battery indicator bar on LCD display is only an approximate indicator of the remaining charge.
- Frequent accelerating and braking will drain the battery charge more quickly than using it to maintain a consistent speed ride.
- A battery will drain about 5% for every 8 hours of being left in stand-by mode.
- If you are not going to use the battery for an extended period of time, take out the battery and store it in a cool, dry place.
- Do not use battery when it has less than 10% capacity left.
- Our bike is resistant to splashing, but not water-proof. Please do not ride the bike through water deeper than 17.5 cm. The controller box will short out.
- If you have been charging your battery for more than 12 hours and it is not yet fully charged, take it off the charger and contact MJM WHEELS™.
- The charger may get warm to the touch, so make sure you charge they are in an open area and do not lay anything on the charger unit while charging
- ·Be friendly to the environment! Be sure to recycle your old batteries at a local battery recycling center. Do not throw them in the garbage

# Battery Storage

## How to store your battery for a extended time?

Charge the battery every 3 months to avoid capacity loss. Batteries slowly self-discharge when left unused for a long time. If a battery is allowed to reach a critically low voltage, their lifespan and capacity will be permanently reduced.

Always disconnect your charger from the wall outlet and battery before storing the battery.

Avoid storing your battery in extreme temperatures, whether hot or cold.

Batteries are best kept in a cool, dry place. Do not allow batteries to accumulate condensation, as this could cause shorting and corrosion.

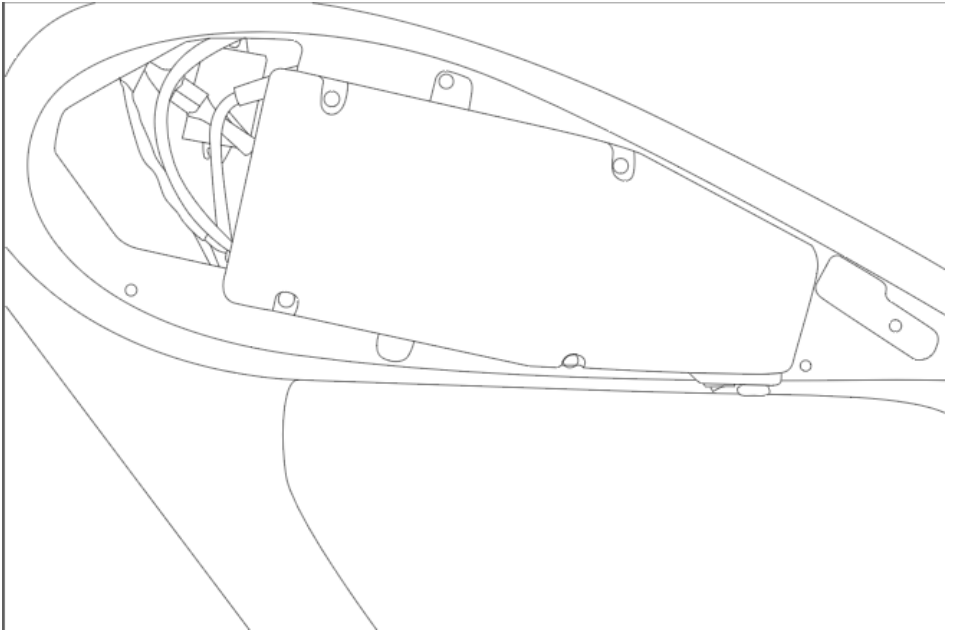

## Uninstall & Install Tank Cover

The RT-20 battery is placed inside the “tank”.

To replace the tank cover, or battery, you need to remove the tank cover by removing 2 bolts on each side. Use 5mm Allen Key.

To remove battery, use the same 5mm Allen Key to remove 4 bolts on the battery. You will need to uninstall the tank cover on both sides to replace the battery.

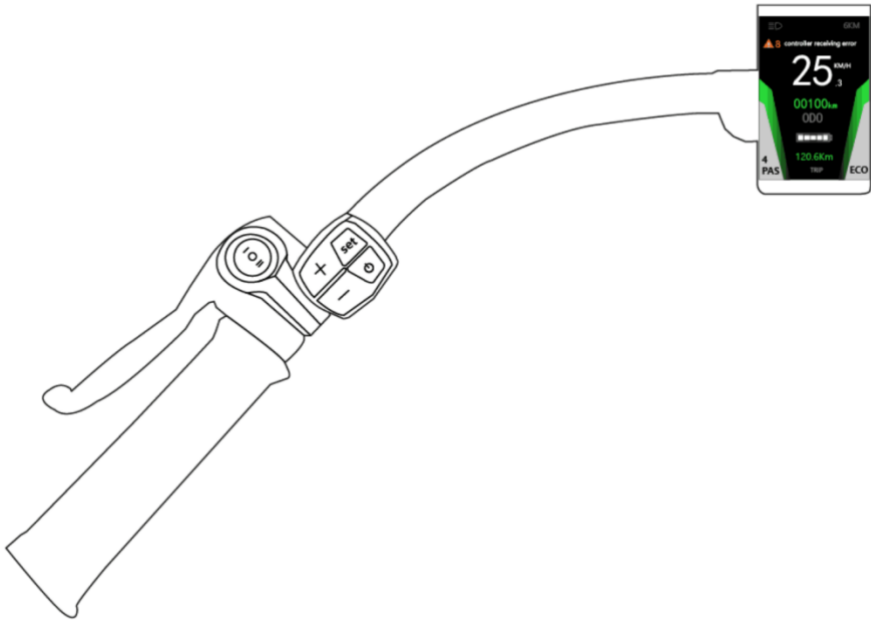

## Head Light Control

On the handle bar, there is a separate switch for head light. Push the button

- Downside: Low Beam
- Upside: High Beam

Don't forget to switch off the light and battery when you finish riding. This operation helps extend the battery life.



## LCD Brief Manual

- To switch on the eBike system, press power button on handle bar. Repeat to shut off the system.
- After switching on the eBike system, you can press Set button to switch between ECO, STANDARD, and POWER modes
- Press + or – to adjust PAS speed level. There are 5 PAS levels by default.
- Hold the Set button for 2 seconds to enter setting interface, where you have the options to customize.
- For more advanced settings, visit [www.mjmwheels.com/pages/setup](http://www.mjmwheels.com/pages/setup)

# Troubleshooting

If there are errors about the electronic control system, the error code will appear automatically.

Error Code	Definition	Solution
1	Current error or MOS damaged	Replace controller
2	Throttle Abnormality	Disconnect throttle wire (located in controller box, or in front of handle bar if the bike has water proof quick release connector) to see whether the ERROR code disappears. If it does, replace throttle.
3	Motor Abnormality	Re-connect motor wire (located underneath chain stay at right side). If still does not work, replace a new motor.
4	Motor Hall Abnormality	Contact with seller, return full rear wheel



		to replace a motor rotor.
 5	Brake Abnormality	Disconnect 2 brake lever wires (located in front of handle bar to see whether the ERROR code disappears. If yes, replace the brake lever and reconnect brake lever wire to controller.
6	Under voltage	Fully charge the battery
7	Motor stalling	Do not block motor from rotating freely
8	communication controller receiving error	Disconnect all wires (brake lever, display, throttle, and motor) then reconnect. Check all connectors are in good connection.
9	communication display receiving error	

## **As a final check, please go through this checklist to make sure your bike is properly assembled and safe to ride:**

### **■ Handlebars**

- ☑ Ensure handlebars are straight and secure and all relevant bolts are tight.
- ☑ Test that they are securely attached to the forks by gripping the front wheel between your legs and attempting to turn the handlebars.

### **■ Wheels**

- ☑ Ensure the front and rear mudguard stays are tight.
- ☑ Check that the quick release mechanism is tightly gripping the front wheel.

### **■ Seat and post**

- ☑ Ensure that the seat is straight and secure.

### **■ Pedals and chain**

- ☑ Ensure the pedals are fully wound in, and tight. .

### **■ Chain**

- ☑ Ensure that the chain is properly set up the gears

## ■ Brakes

☒ Test front and rear brakes whilst rolling the bike forwards – both wheels should stop completely.

☒ Test that there more than a fingers width between the grip and the brake lever when fully depressed.

## ■ Rack

☒ Ensure that the rack is secure and that all visible bolts are tight.

## ■ Kickstand

☒ Rock the bike gently from side-to-side to ensure that the kickstand does not wobble. Tighten the bolt on the frame directly above the kickstand if necessary.

## ■ Tires

Pump the tires to the point that they are firm and cannot be deformed with your thumb. This is equivalent to roughly 60ppi of pressure for the Sport and Classic models and 50ppi for the Urban.

## ■ Electrics

☒ Test the pedal assist function by rotating the pedals with the rear wheel raised.

☒ Fully charge the battery before use.

# Before riding:

Adjust the height of the handlebars and saddle to suit the rider, whose toes should be able to just touch the ground.

- Check that all lights and displays are working.
- Check regularly to ensure that the electrical connectors between the bike and battery are clean.
- Check the brakes: this can be done by putting the front brake on and pushing forwards. Do the same with the back brakes. The bike should not move and the brake levers should not touch the handlebars. The brakes should work without having to press down too hard on the handles.
- If your bike has a quick release on the front wheel then check that this is properly tight in its position within the front forks. Quick release mechanisms can more easily work loose than conventional axles and so should be checked often for tightness.
- Wear an approved safety helmet when riding your e-bike:
- After mounting the bicycle, turn on the main switch, the power display light will come on, indicating power is connected
- Release the kickstand, mount the bike, placing one foot ready to pedal, check that it is safe to proceed, and then set off. You will feel the motor as you begin to pedal.

■As you cycle, the battery power will be consumed, and the power level indicator lights will indicate this reduced battery life. .

■Use both brakes together when stopping; do not use only one brake.

■Remember when riding in wet or snow conditions your brakes will be less effective and a greater stopping distance is needed.

■Do not ride through deep puddles or streams. Ensure that water never reaches the motor and controller level. This could short out the power and void the warranty

■Do not carry passengers

■Do not ride under the influence of drugs or alcohol, or when feeling unwell.

■Do not ride at night without lights. If the lights are not working it may be safer to walk with the bike.

# MJM WHEELS™ LIMITED WARRANTY

To make a warranty claim you will need a copy of the original receipt showing the ebike model, date of purchase, ebike serial number as retailer information

The warranty is limited to the terms listed below:

Motor and controller: 1 year for parts. 3 months for labor

Frame: 3 years, 1 year for labor

Charger: 1 year for parts

Battery: Warranty on the battery starts the date of purchase of the

ebike as new. The battery is sealed and cannot be opened or fixed. The battery

should not have a percentage of nominal charge retention of

60% or less. Misuse of the battery, negligence or attempt to open

or repair it will void the warranty.

Consumables: Components subject to wear are not covered by the warranty: Tires, inner tubes, brake lines, brake pads, basket, wheel lining tape, light bulbs, LEDES, fuses, etc.

Always follow care and preventive maintenance procedures

Always keep receipts from any services performed to the ebike by an authorized distributor or service center.

The warranty will be voided by any of the following circumstances:

- (1) Failure to follow all directions or recommendations listed in this warranty and user's manual.
- (2) Cycling collision, accident or ebike damage caused by careless parking or storage.
- (3) Acts in violation of laws and regulations.
- (4) Service or maintenance work not performed by an accredited technician. performed service or maintenance on components
- (5) DIY repairs on electronic components.
- (6) Abusive use the ebike in off-road terrain, mud, snow, water, sand, gravel and water puddles.
- (7) If ebike is used as rental unit
- (8) Damages caused by natural disasters such as earthquakes, lightning, fire, flooding and other hazards .
- (9) Rust and/or paint fading caused to heavy exposure to rain, hail, snow or sunlight.
- (10) Overloading beyond recommended capacity .
- (11) Damages caused by nails, needles, broken glass , debris , sharp rocks or other foreign objects .
- (12) If ebike is used for stunting such as jumping from ramps, stairs or elevated surfaces.
- (13) If ebike is used in competitions or racing

(14) If ebike has been modified for any purposes on the motor, electrical system, suspension frame, wheels.

(15) Use of other components not approved by the manufacturer

(16) Damages resulted from improper transportation

Due to the nature of the product some components must be purchased exclusively from the manufacturer. These would include, but are not limited to limited to the battery, motor, main gauge cluster, controllers, Led headlights, brake drums or disc rotors and pads etc. Other components such as tires, tubes, saddle, racks, and baskets may be used from market-ready or compatible products previous approval from the retailer or manufacturer.



**MJM WHEELS LTD.**

Get more information of about promotions or new product launches at:

**[www.mjmwheels.com](http://www.mjmwheels.com)**